

# JAMES SAID

112856 CEILING LAMP ROUSSEAU

ASSEMBLY INSTRUCTION

1

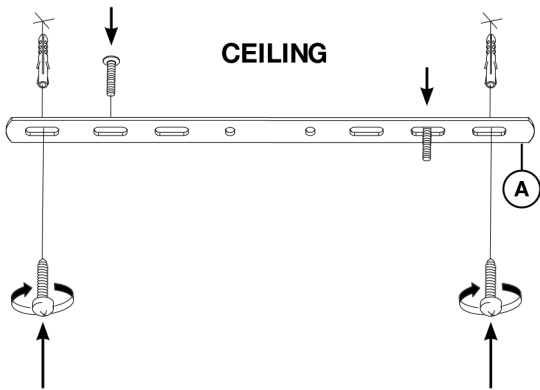

2

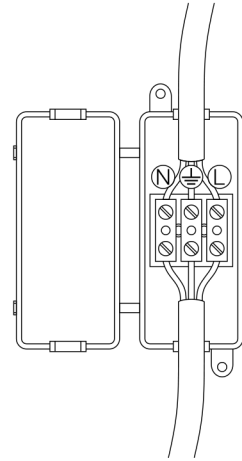

3

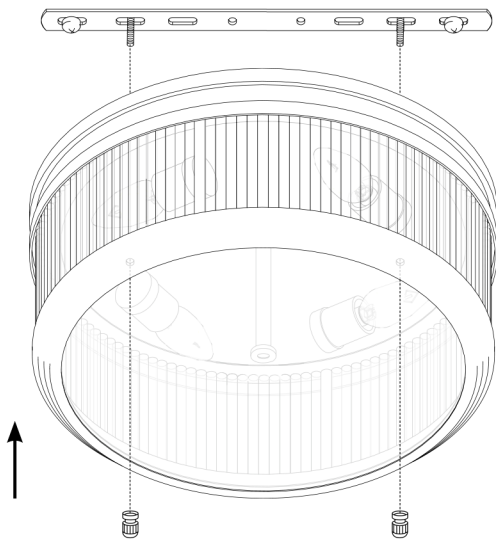

4

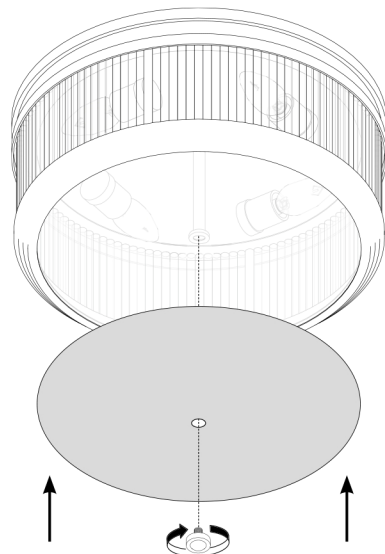

Turn off the electricity supply at the main circuit panel before installing.  
Do not connect the electricity supply until your luminaire is fully assembled and installed.

Fix the ceiling bracket (A) to the ceiling by using mounting plugs and screws suitable to your ceiling type.

Connect the 3 power wires according to their colours. Brown is the live wire, blue is the neutral wire, green/yellow is the earth wire.

Place the lamp over the ceiling bracket and secured it with two screws.

Place the bulbs.

Place the glass and secure it with finial

**FINAL**

